

The role of Network Virtualization in the Software Defined Data Center.

Tim Hartman

VMware Network & Security Business Unit

The VMware NSX logo is displayed in the top-left corner of a decorative graphic. The word "vmware" is in a white, lowercase, sans-serif font. Below it, the letters "NSX" are rendered in a large, stylized font where each letter is composed of overlapping, semi-transparent geometric shapes in shades of blue, green, and yellow. The background of the graphic consists of several overlapping triangles and polygons in various shades of green, blue, and yellow, creating a dynamic, abstract pattern.

vmware®
NSX

vmware®



Software-Defined Data Center

The ideal architecture for private, hybrid and public clouds.

All infrastructure is virtualized and delivered as a service, and the control of this data center is entirely automated by software.

Software-defined data center approach

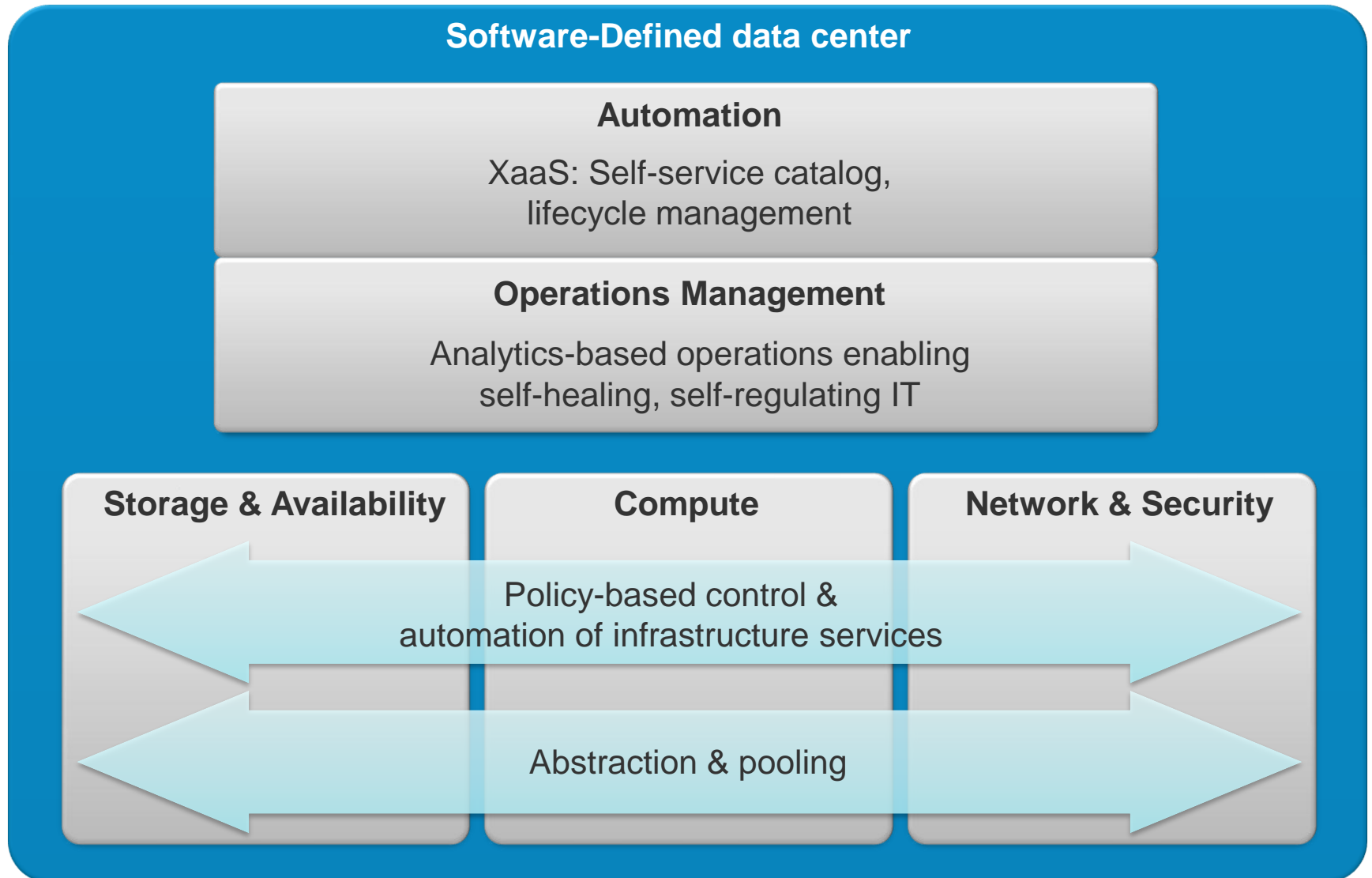

A Major Industry Transformation

Industry Transformation
From
Mainframe To Client Server

Market Transitions

Industry Transformation
From
HDDC To SDDC

Internet

Cloud

Client-Server

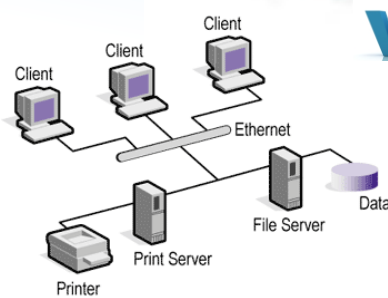

VOIP

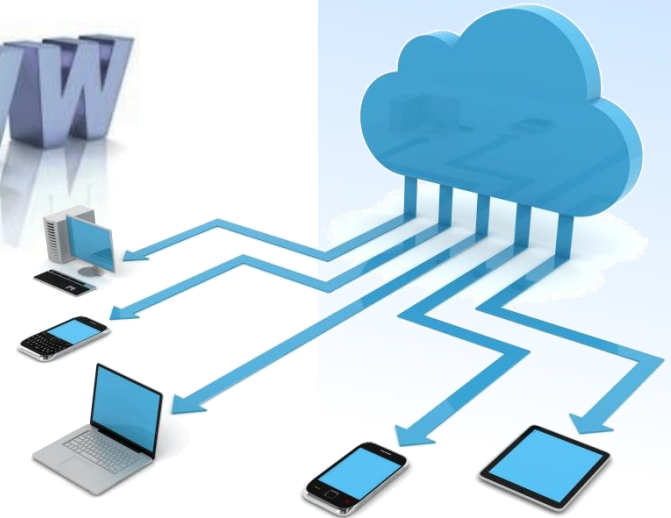

Mainframe



10Base-T

100Base-T

1G Ethernet

10G Ethernet

40G Ethernet

1990

2000

2010

2014

There Are Two Approaches

Hardware Defined Data Center (HDDC)

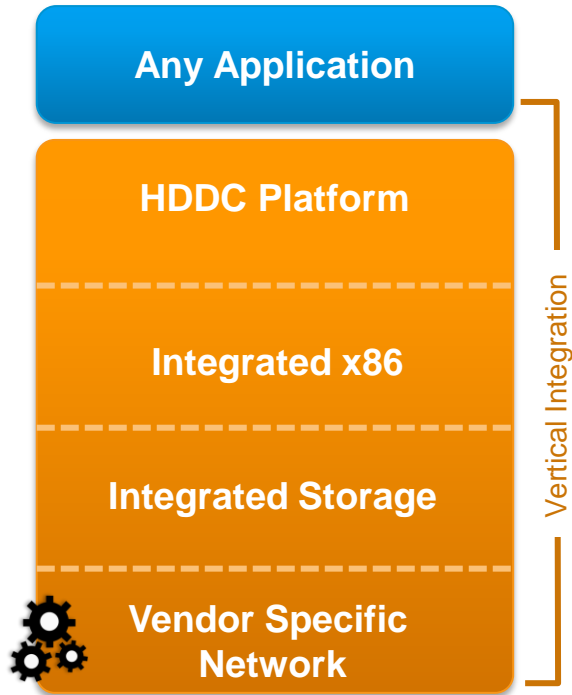

OR

Software Defined Data Center (SDDC)

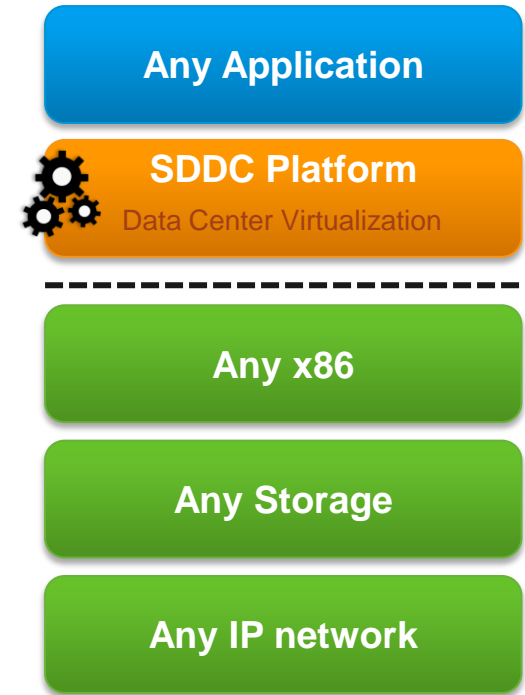

The Anatomy of the Modern Data Center

Hardware Defined Data Center (HDDC)

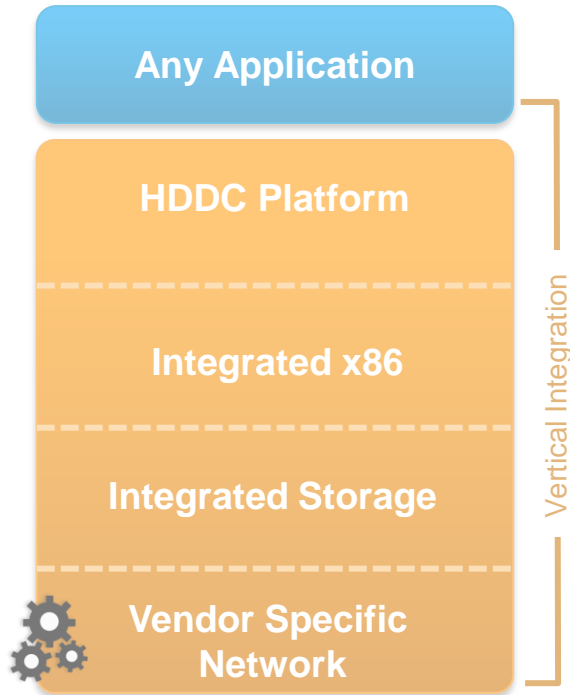

Google / Facebook / Amazon Data Centers

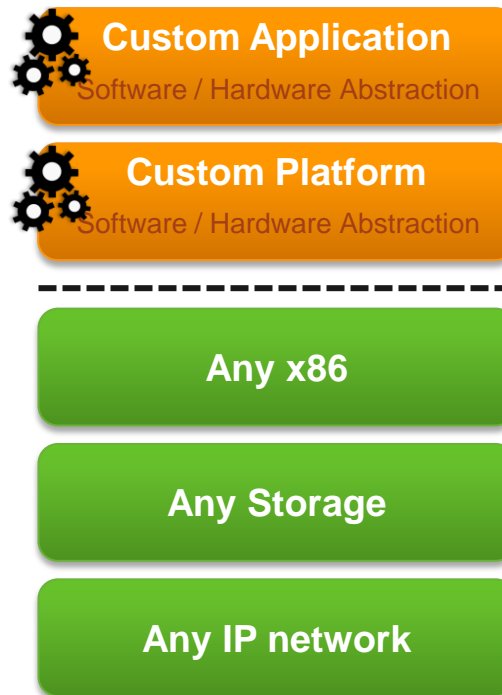

Software Defined Data Center (SDDC)

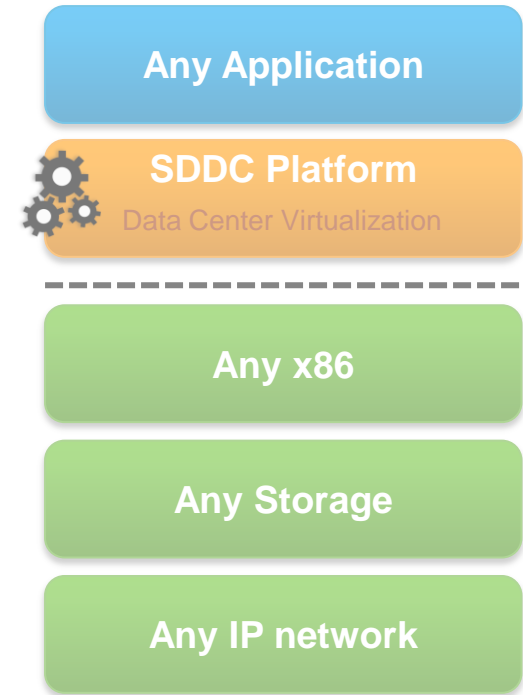

The Power of SDDC

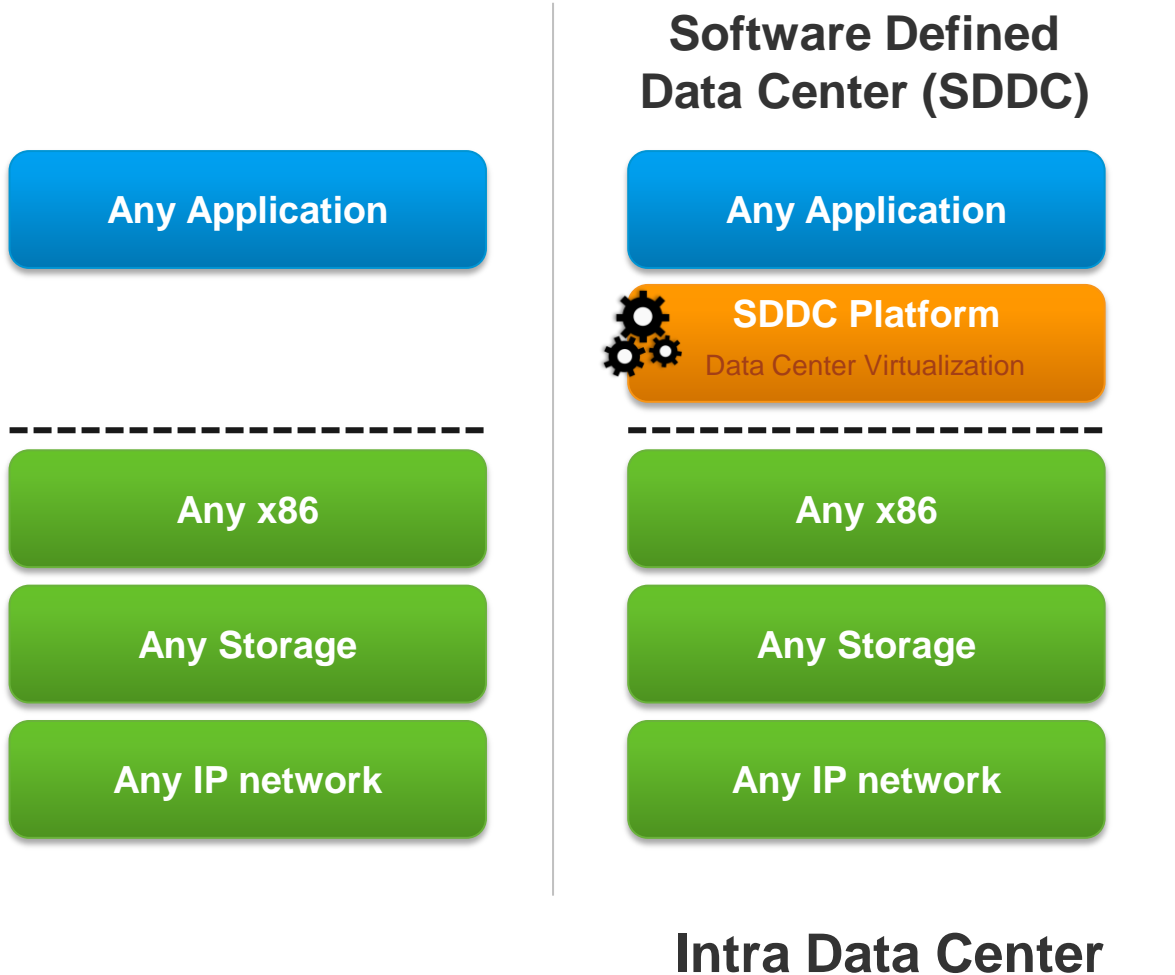

The Power of SDDC

Software Defined Data Center (SDDC)

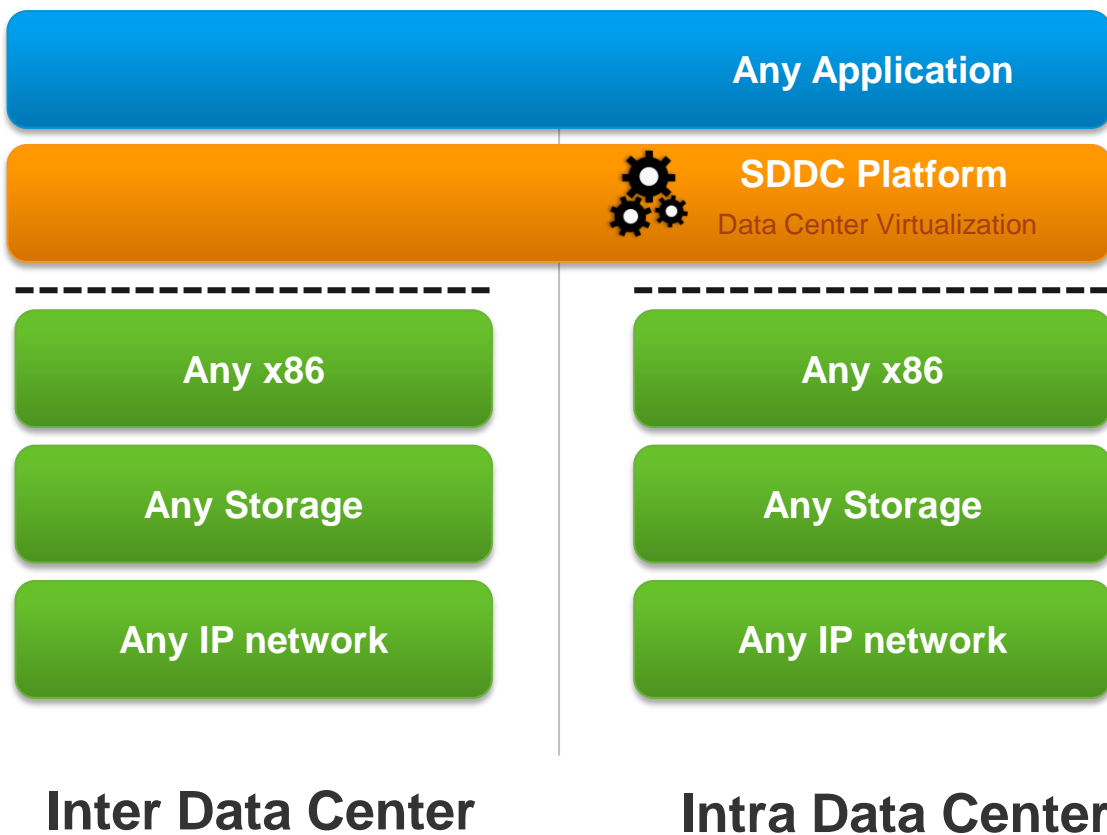

SDDC and the Hybrid Data Center

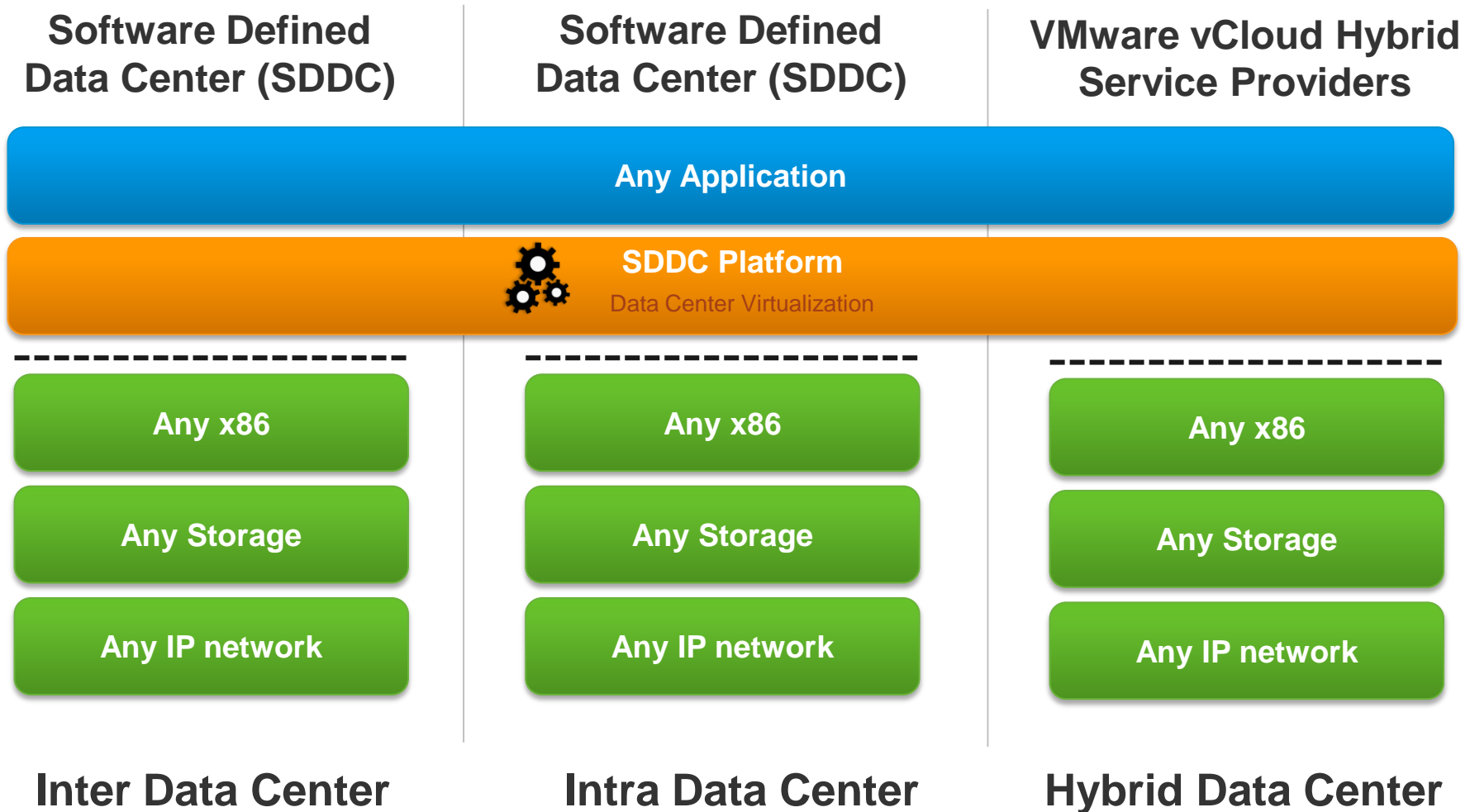

NSX | Network Virtualization

A Data Center Network...

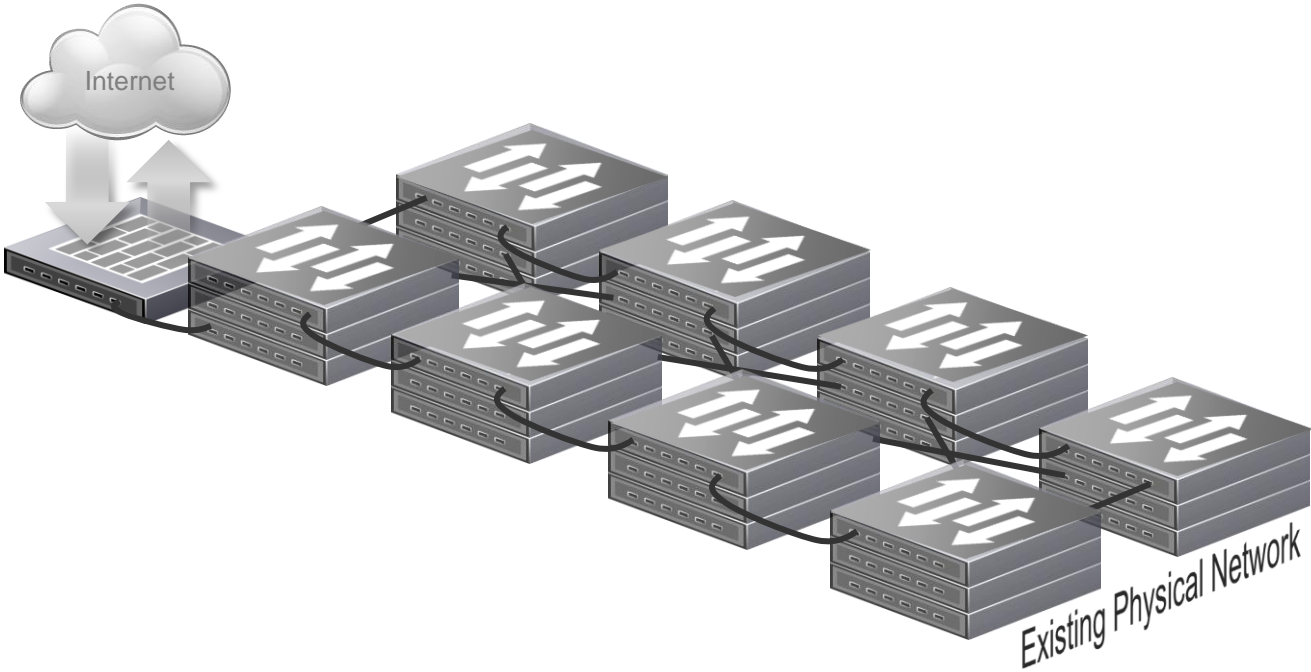

Compute Infrastructure....

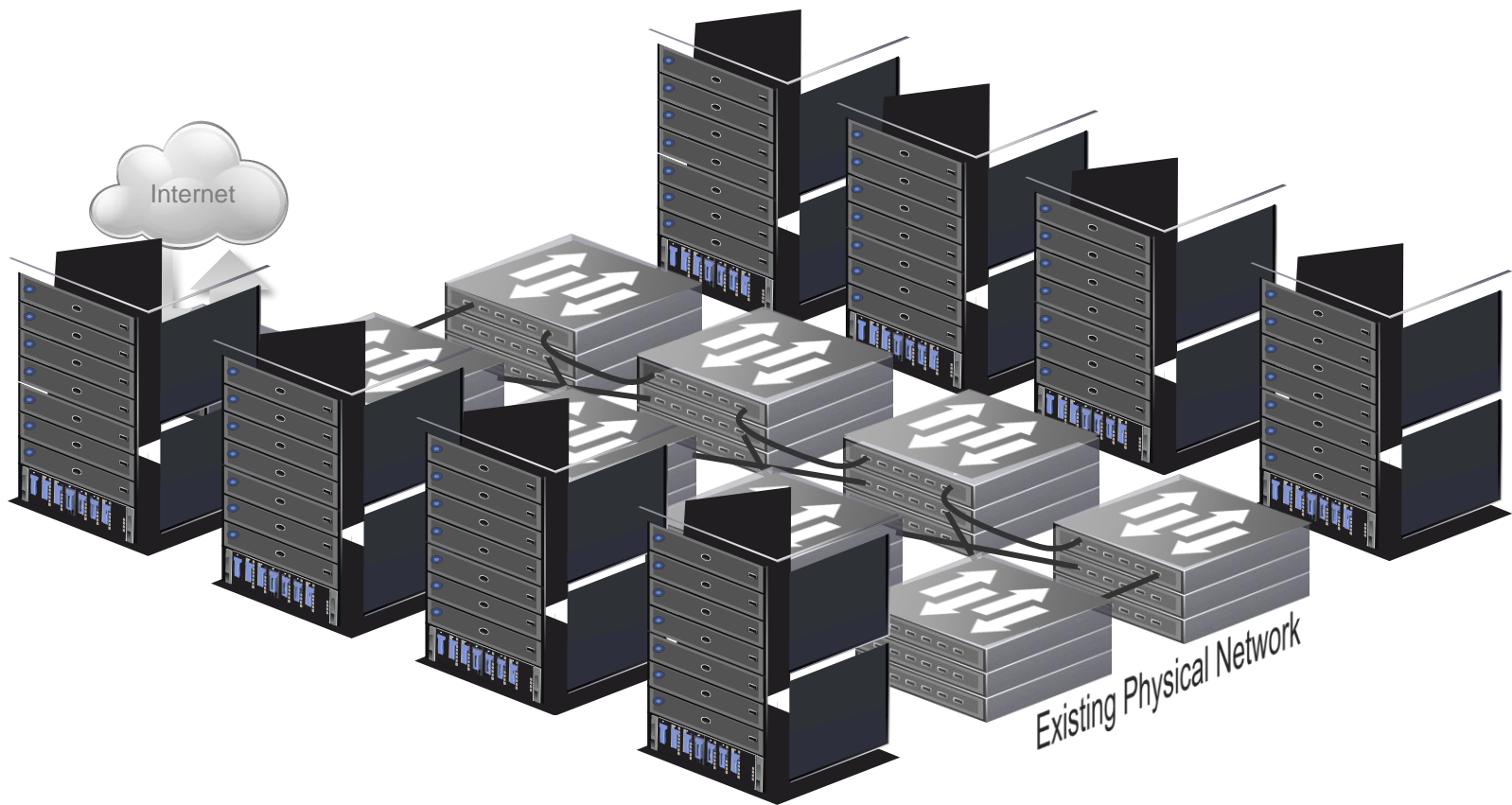

Hypervisors and vSwitches...

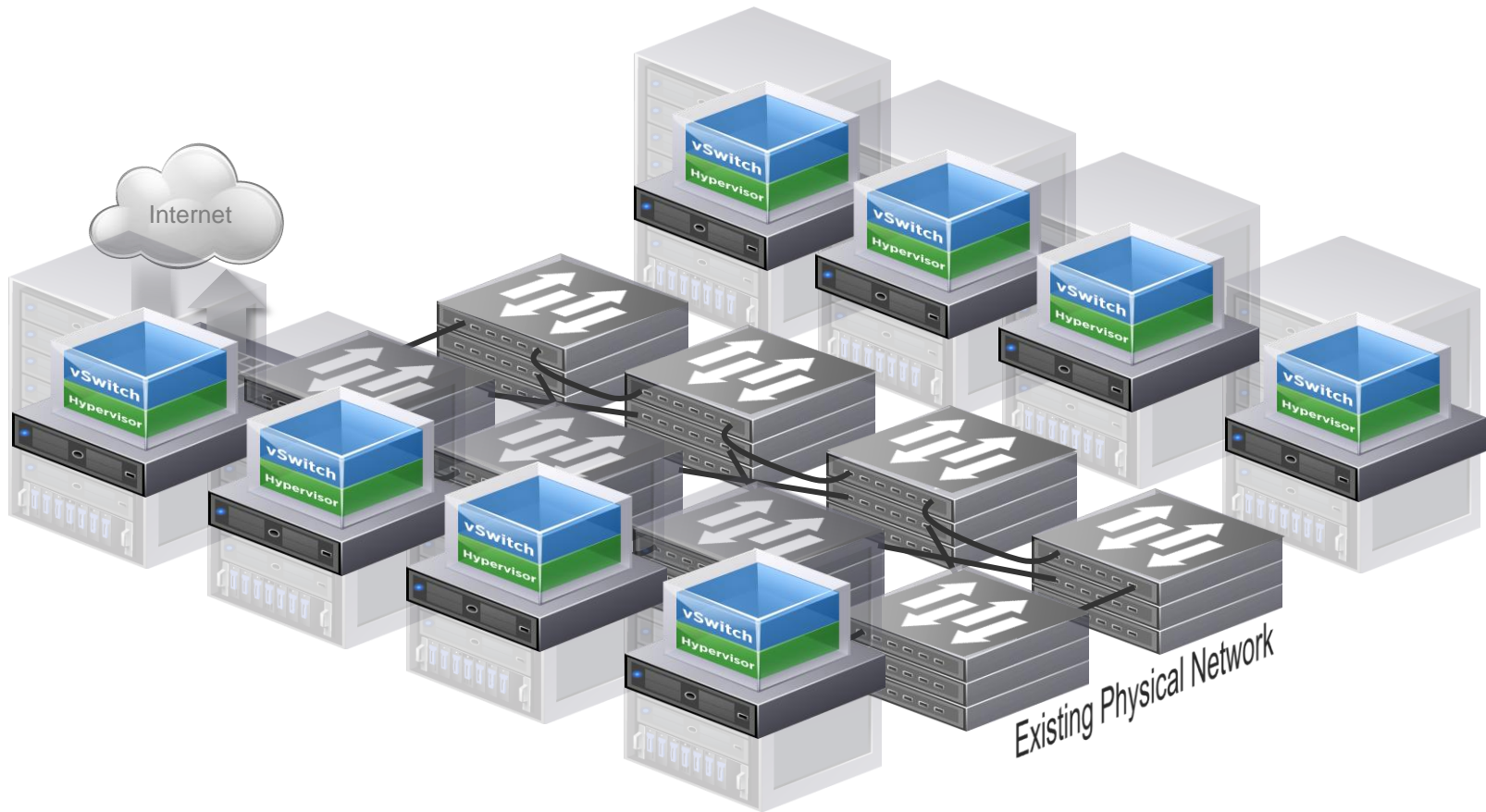

NSX | The “Network Hypervisor”

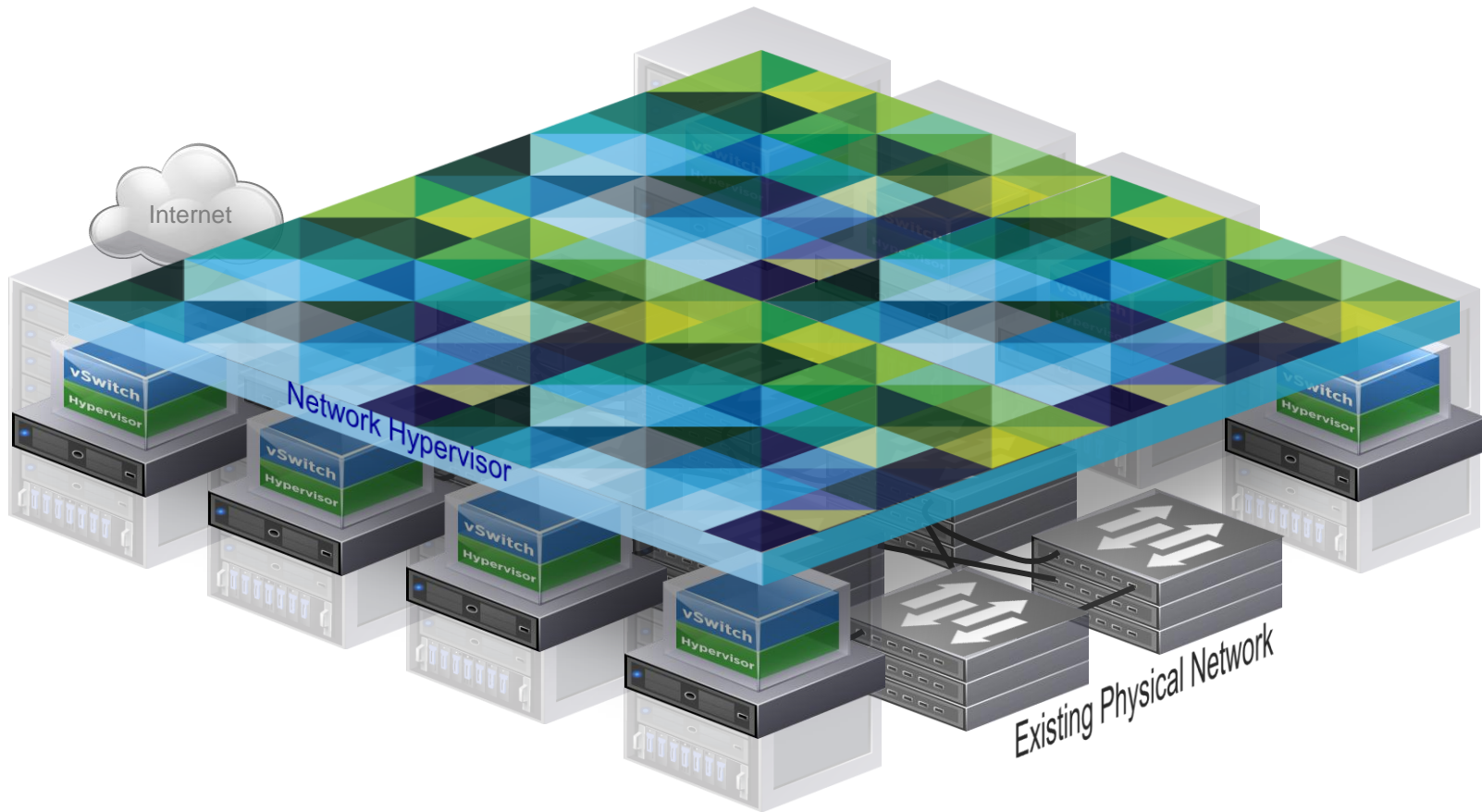

Virtual Networks – Like Virtual Machines for the Network

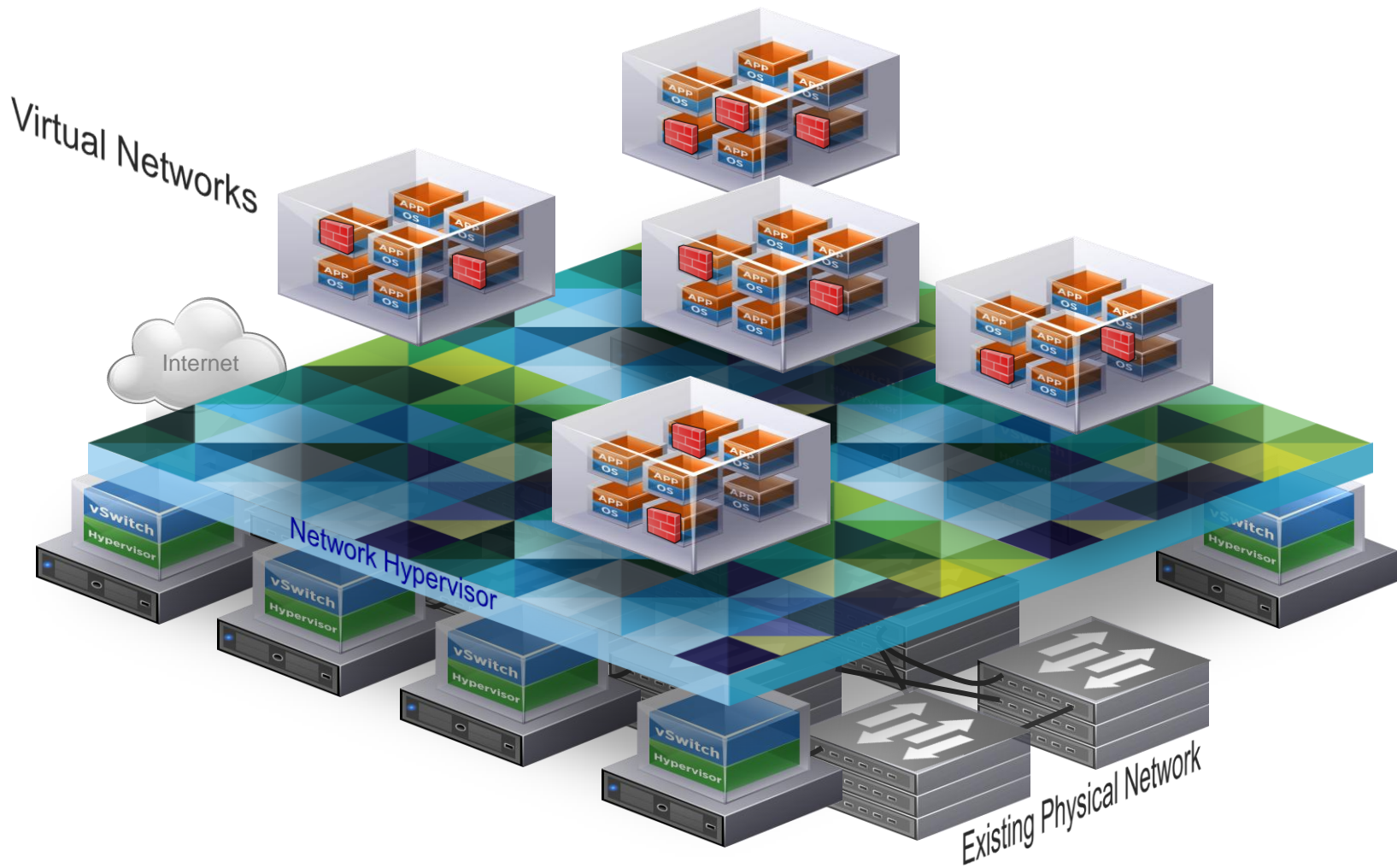

Programmatically Provisioned

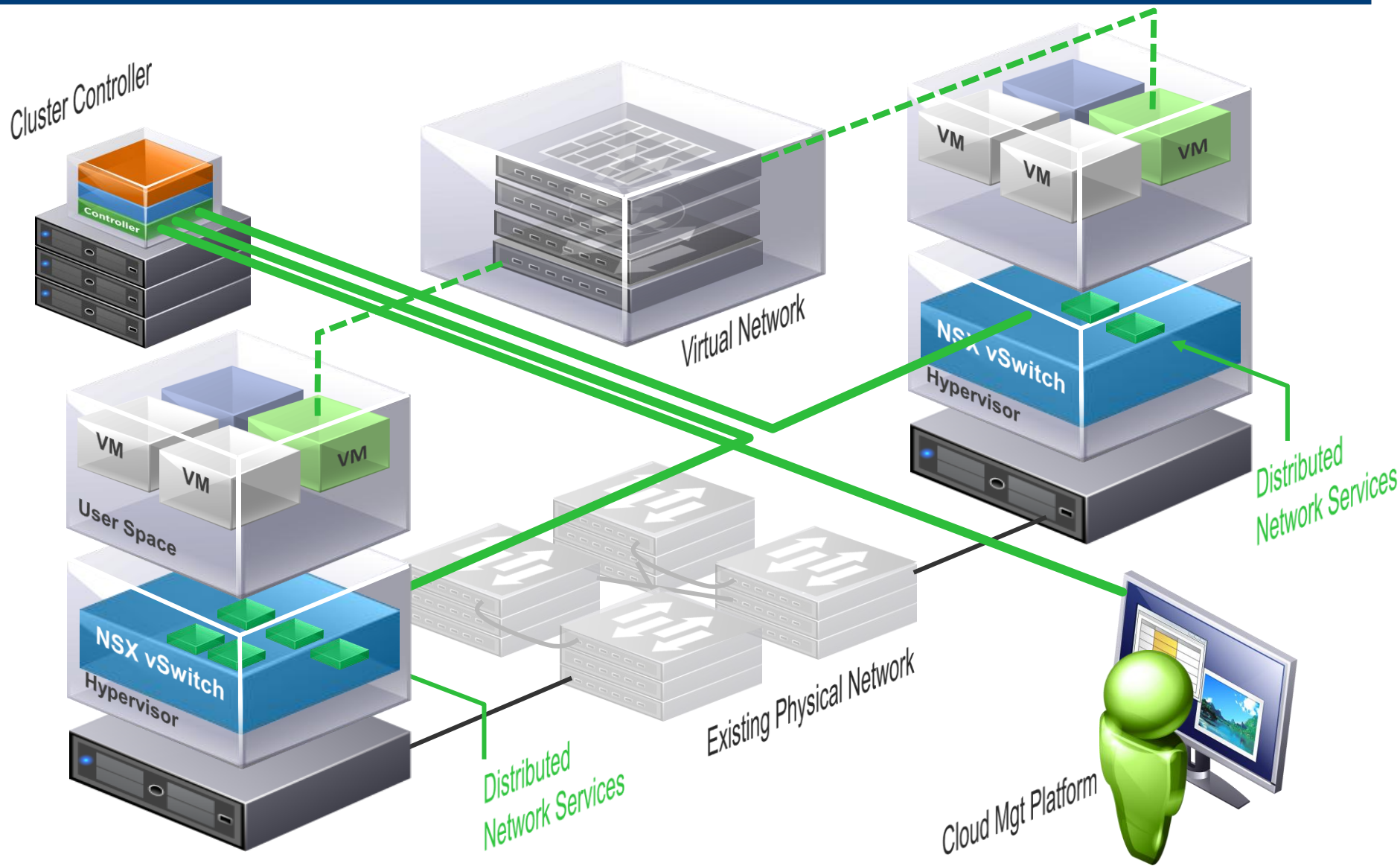

Services Distributed to the Virtual Switch

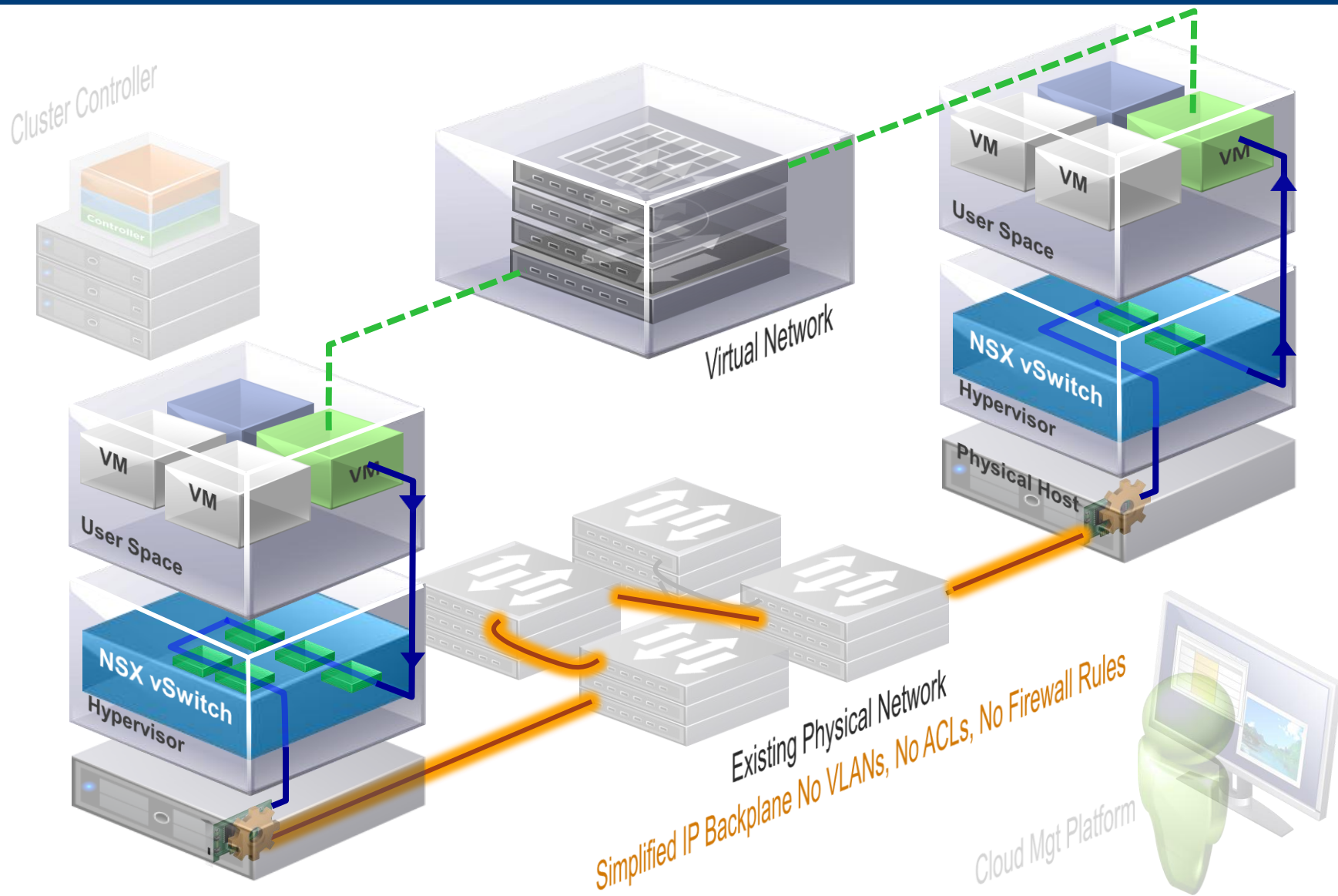

Better Operational Visibility & Troubleshooting

Visibility & Troubleshooting

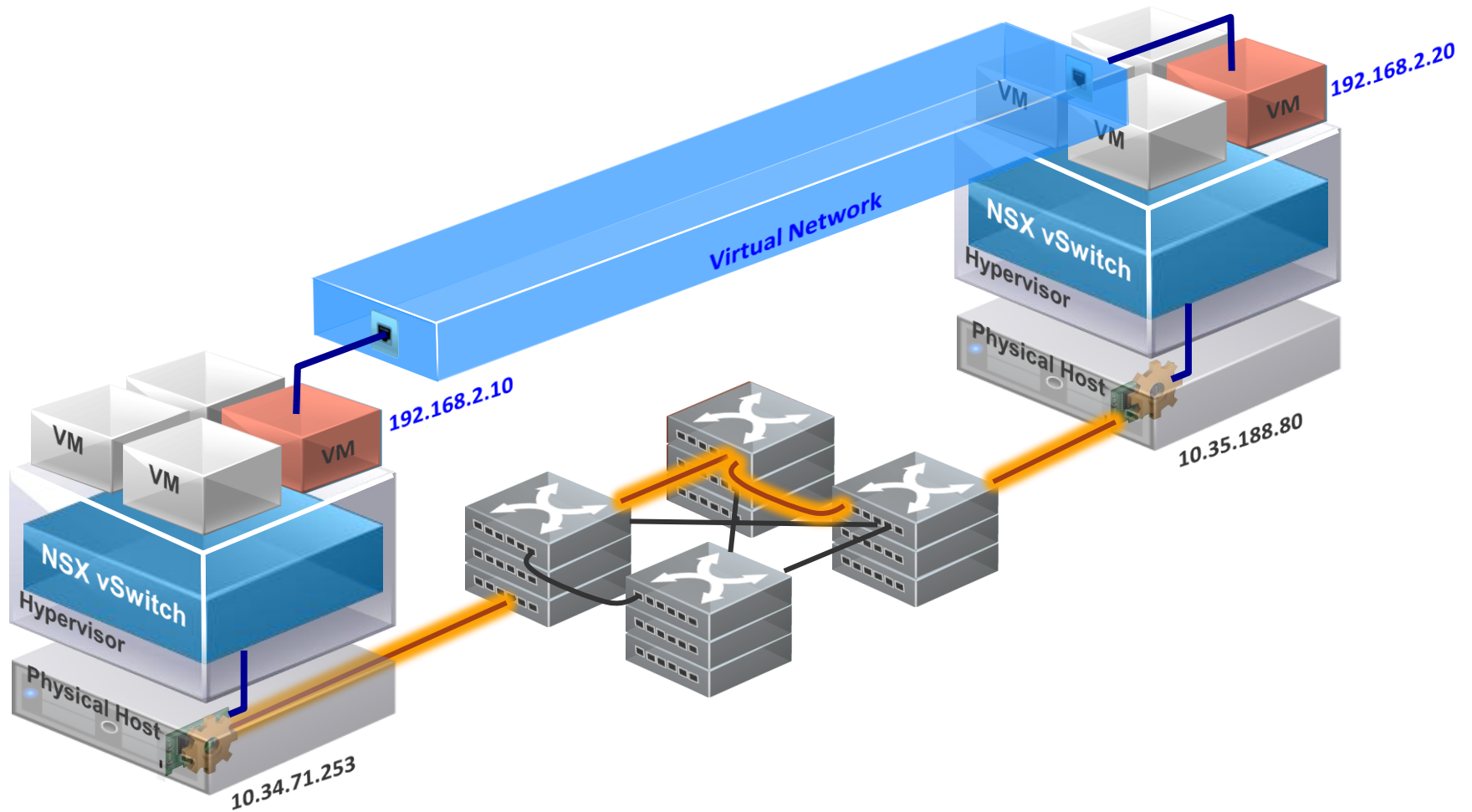

Visibility & Troubleshooting

Port Connection

Select a logical port source type: Logical Switch
Enter a Logical Switch UUID: 01f3bf60-d002-4134-a2e3-0a1bad347961
[Demo 2](#)

Select a Logical Switch Port: 4cea7...10556 (1) fa:16:3e:7ffc:74
Go
Select a Logical Switch Port: a72ec...ca5c8 (2) fa:16:3e:63:d5:9c

All Sections: [Expand](#) • [Collapse](#)

▼ VM

192.168.2.20

▼ Transport Node

server091	Display Name	inap41
Hypervisor	Type	Hypervisor
af6356dc-54fe-4a37-8439-9ba3a195f157	UUID	1038509d-b869-4f6c-a52f-0e9bd8dd40df

Disconnected ● Disconnected ● Disconnected

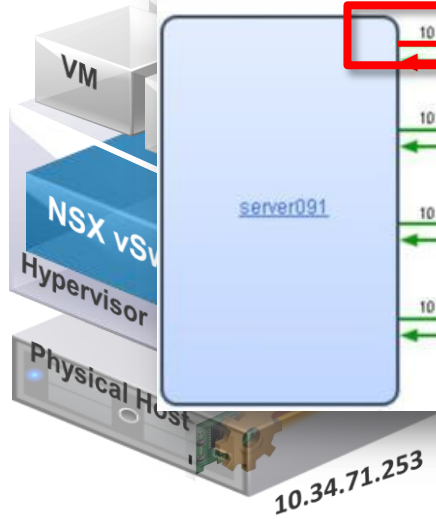
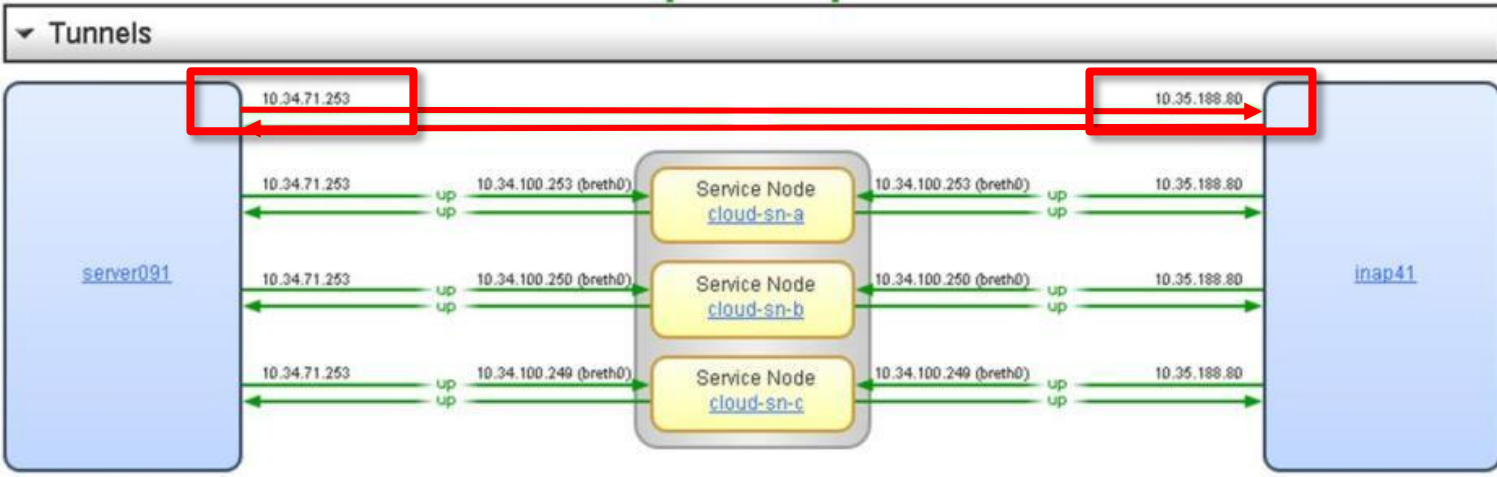

Visibility & Troubleshooting

Use the network troubleshooting tools you use today,
but with better information

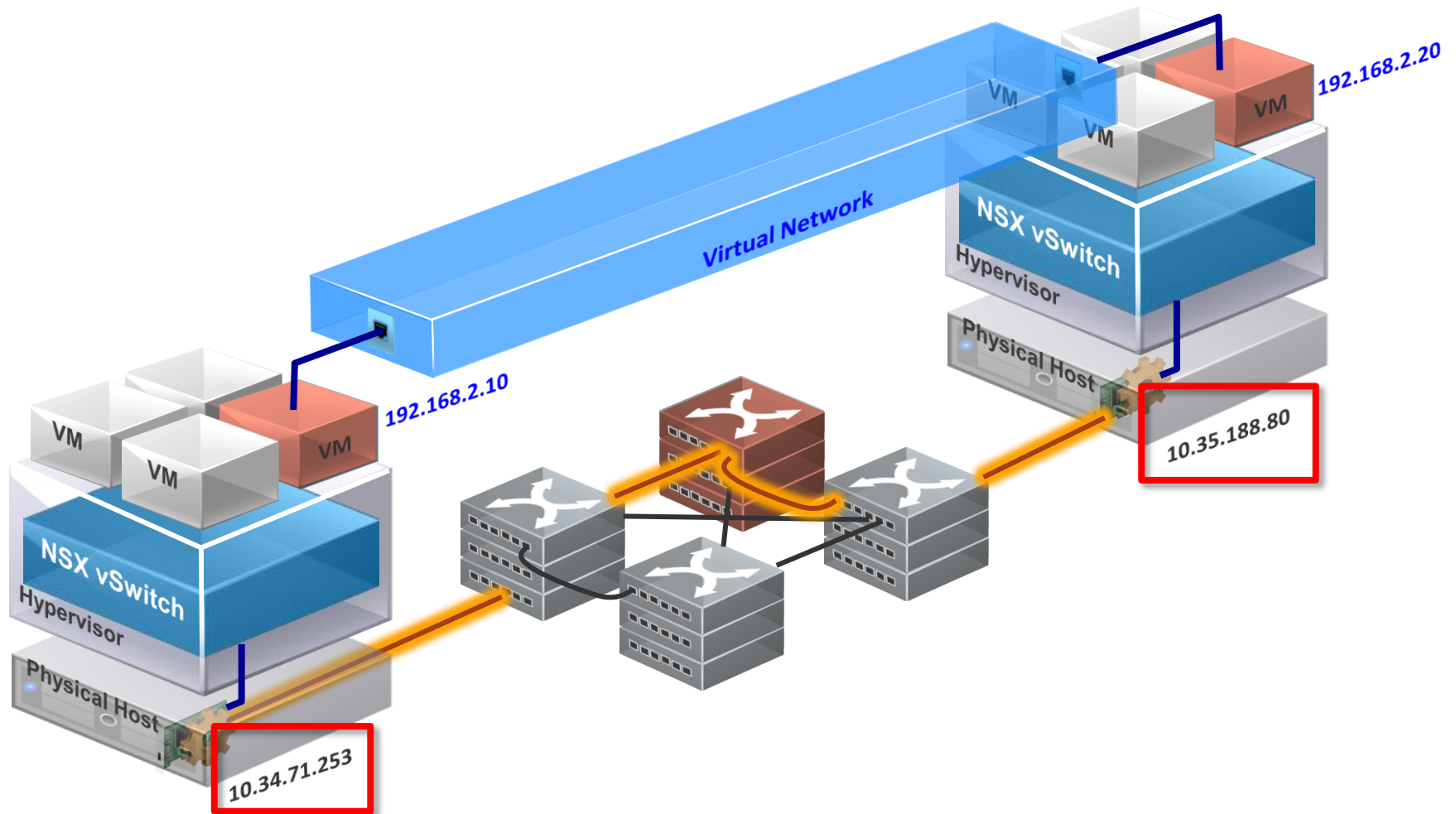

Better Security

Security – Complete Isolation

Virtual Networks are isolated from each other
(Overlapping IP Addresses)

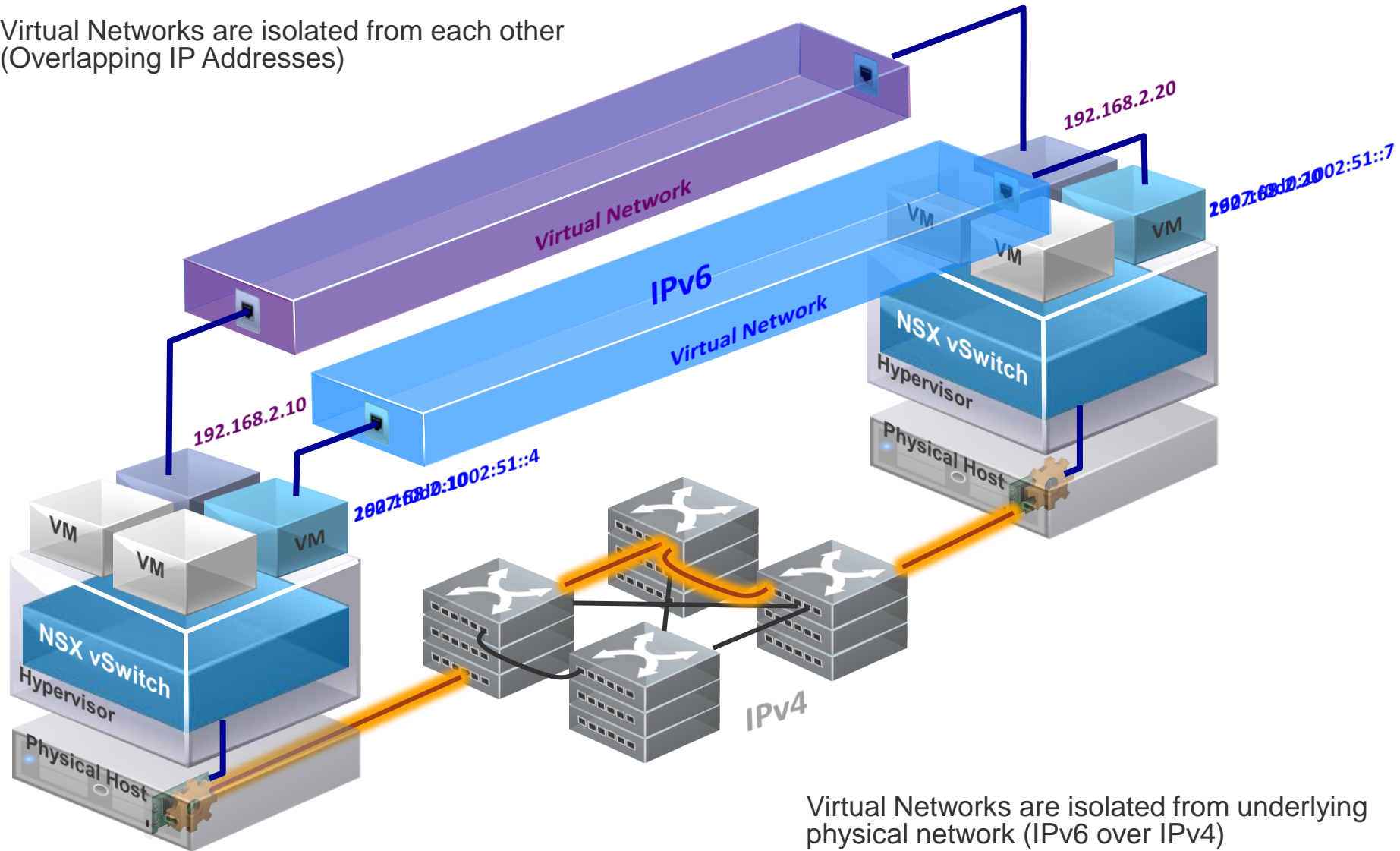

Virtual Networks are isolated from underlying physical network (IPv6 over IPv4)

Central Policies, Distributed Enforcement, Move with VMs

- Reduce Choke Point Security
- Centrally Define Policies, Distribute Rule Enforcement for Segmentation
- Security Policies Move with VMs
- Changes to central policies automatically distributed to affected VMs

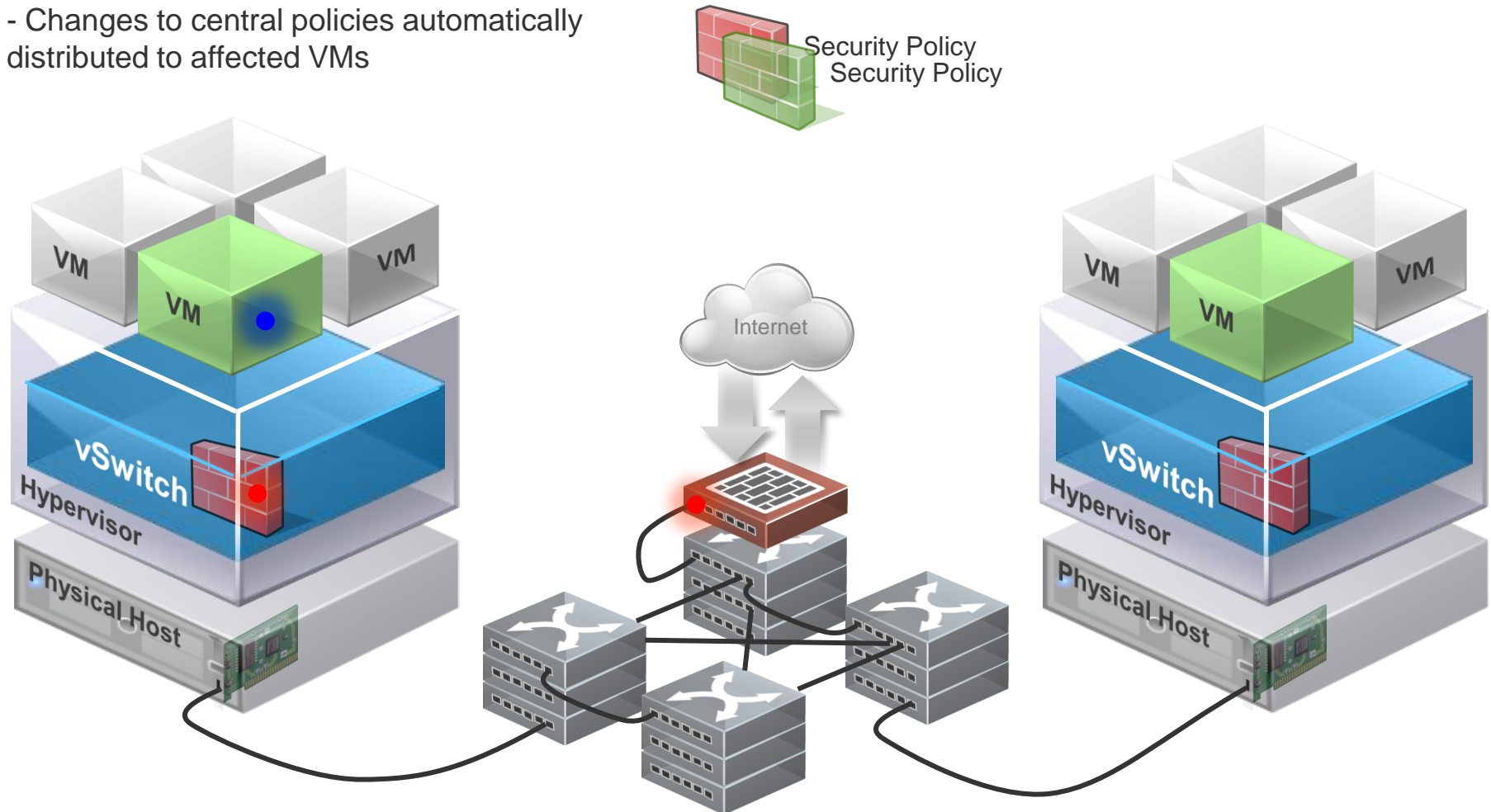

Service Insertion – Example: Palo Alto Networks Next Gen Firewall

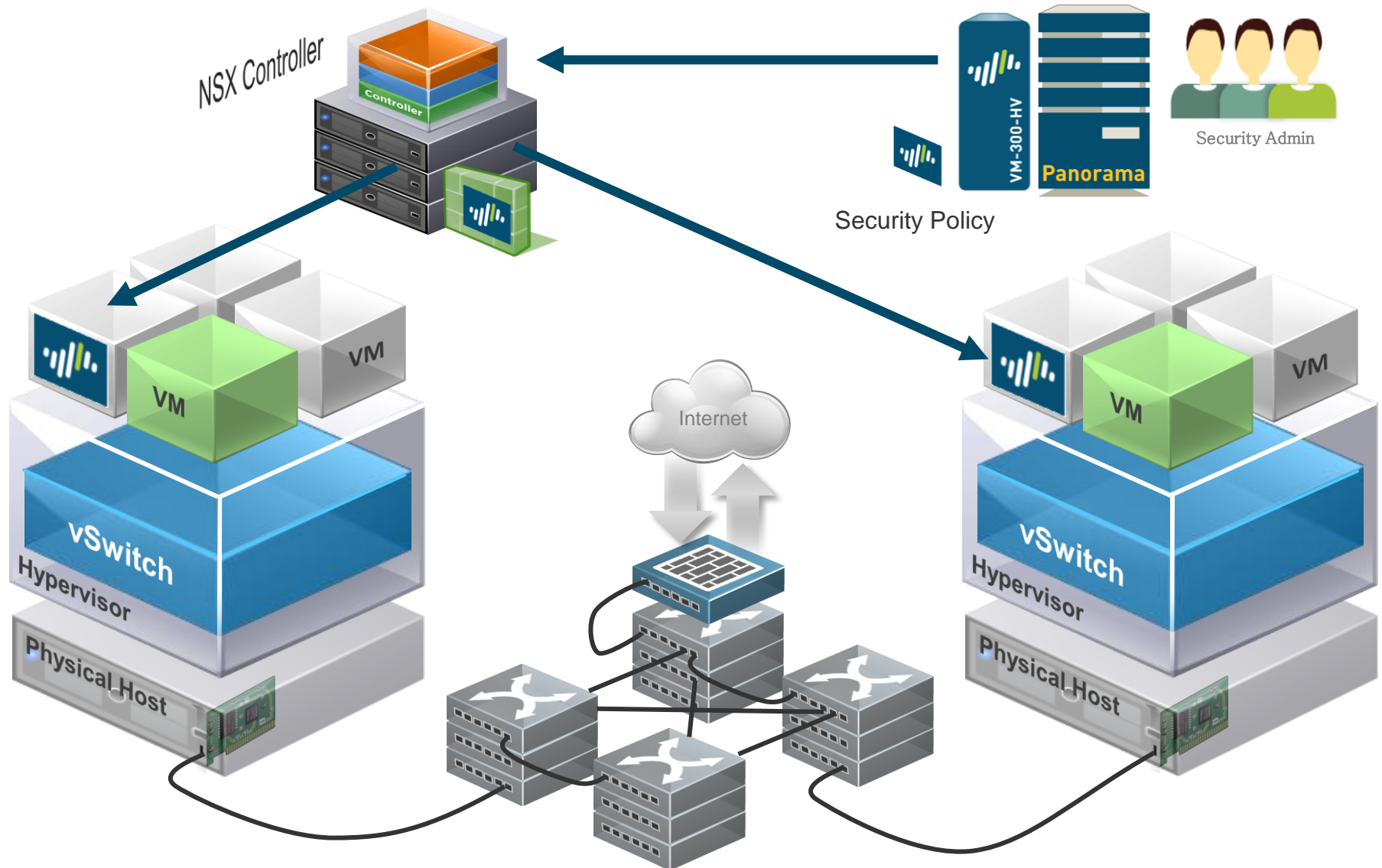

The Power of Distribution

Distributed Routing

East-West Layer 3 / Same host

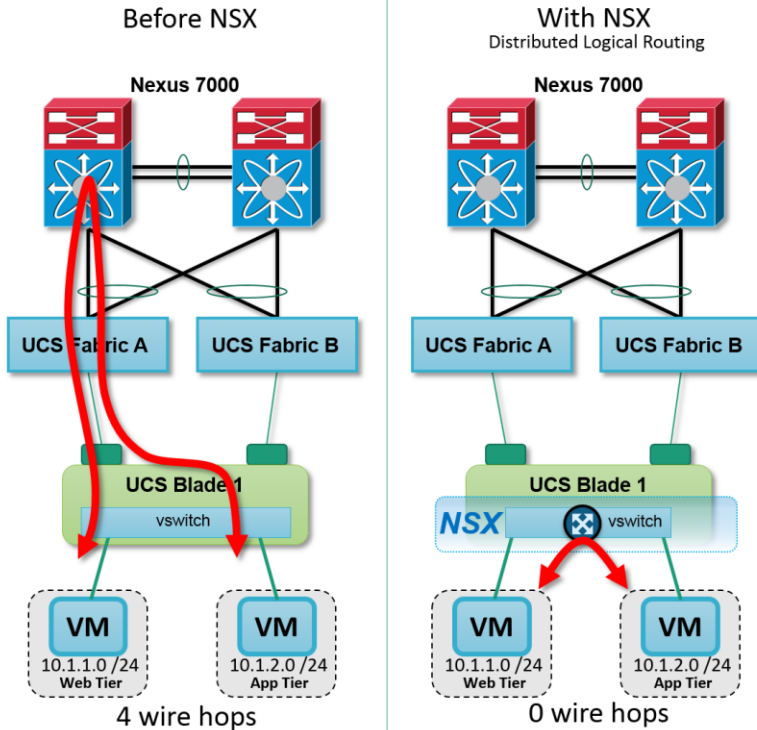

East-West Layer 3 / Host to Host

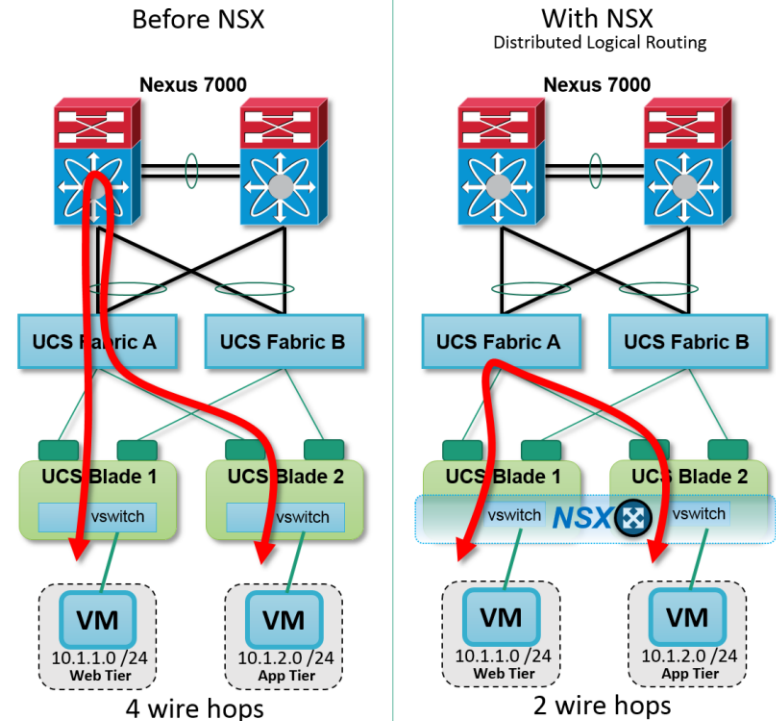

The Power of Distribution

Distributed Firewall

East-West Firewalling / Same host

Before NSX

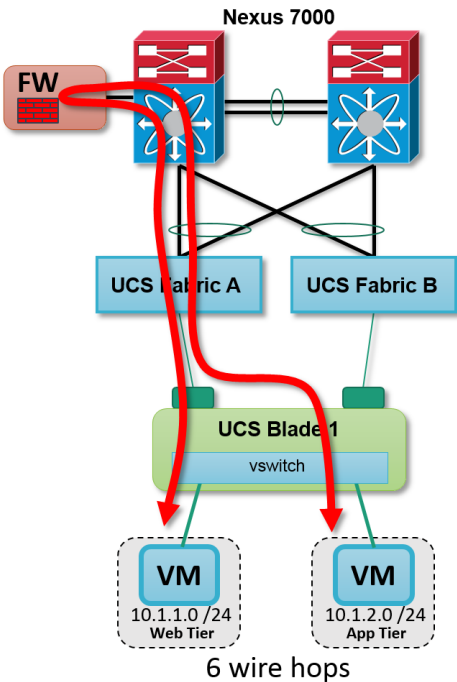

With NSX
Distributed Virtual Firewall

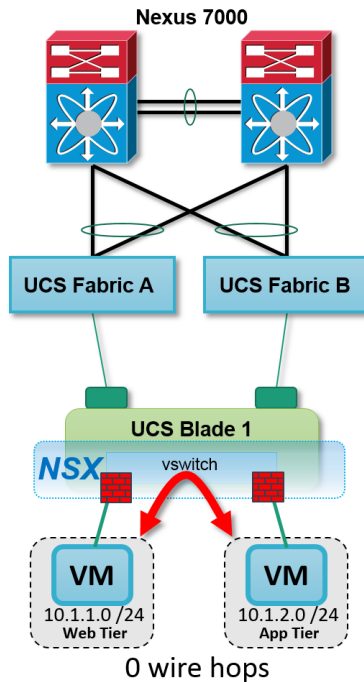

East-West Firewalling / Host to Host

Before NSX

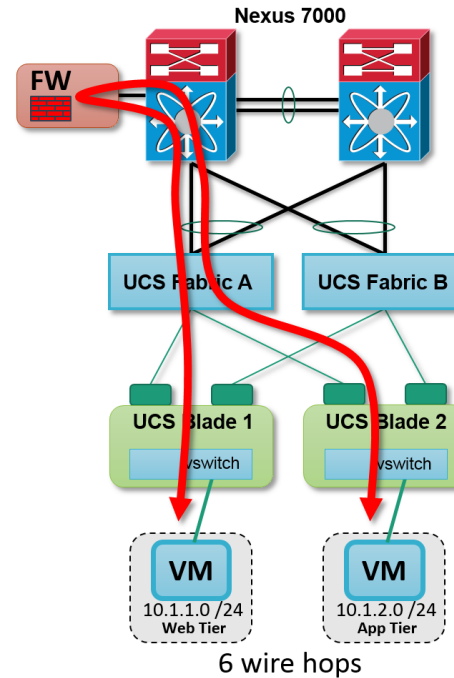

With NSX
Distributed Virtual Firewall

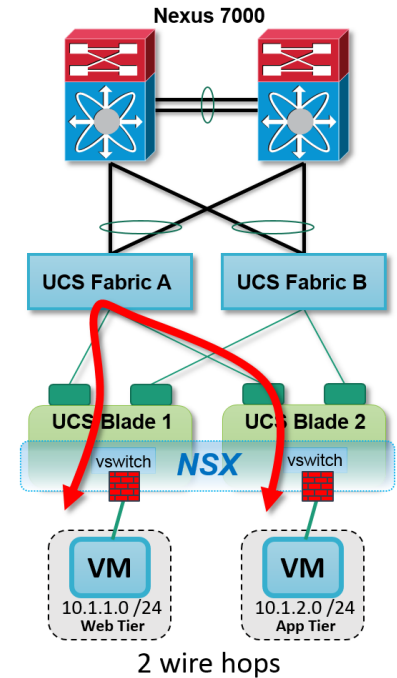

NSX – How it Works

Data Plane

Control Plane

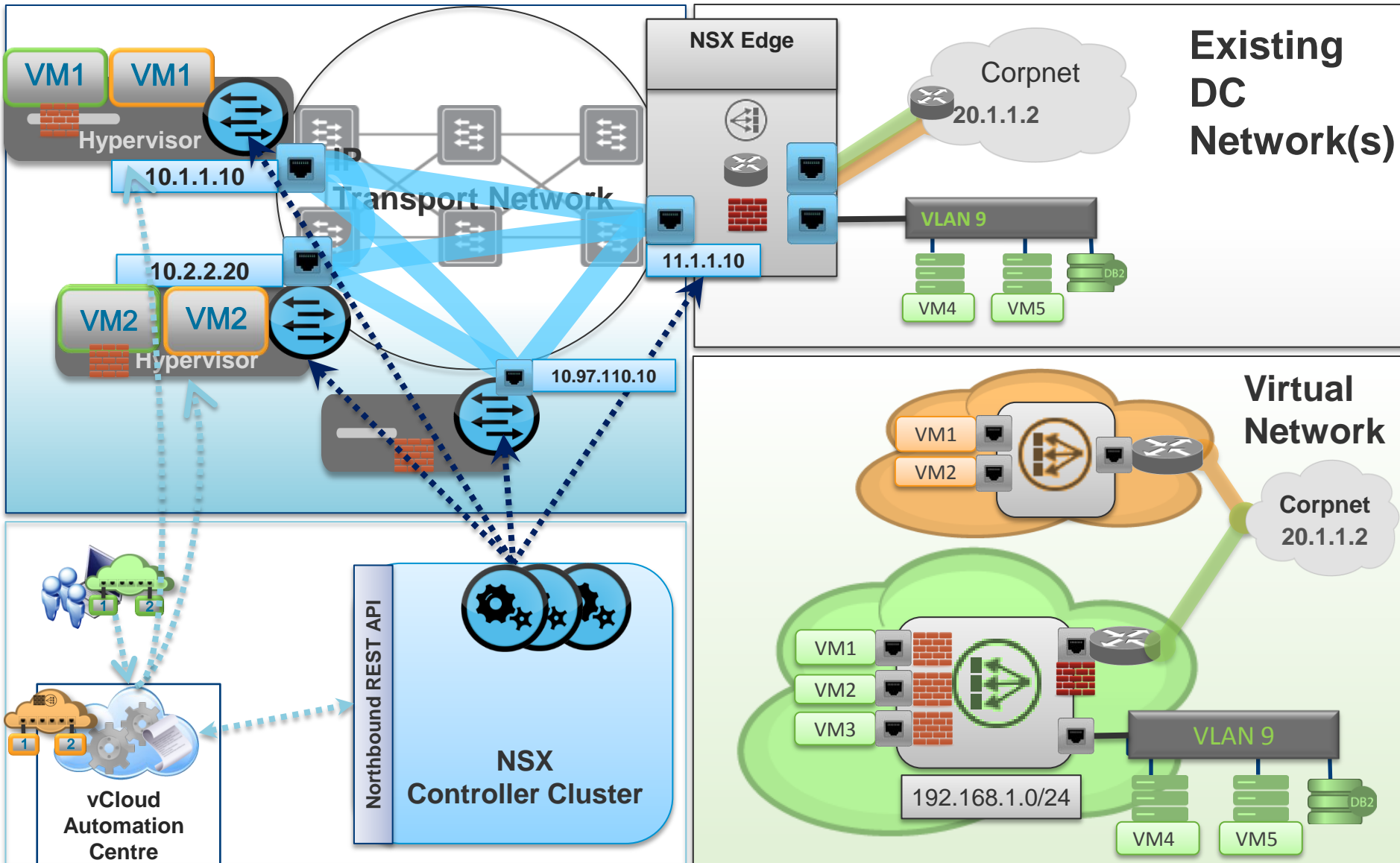

VMware NSX Ecosystem – Technology Partners



VMware NSX – Networking & Security Capabilities

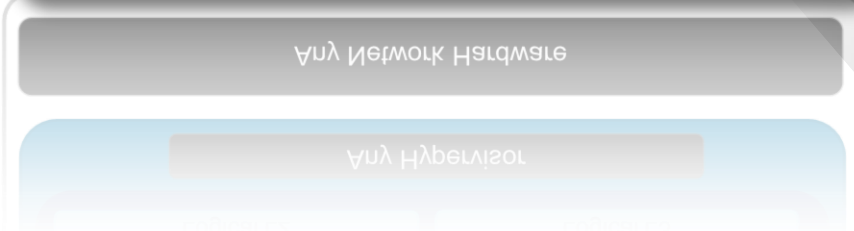
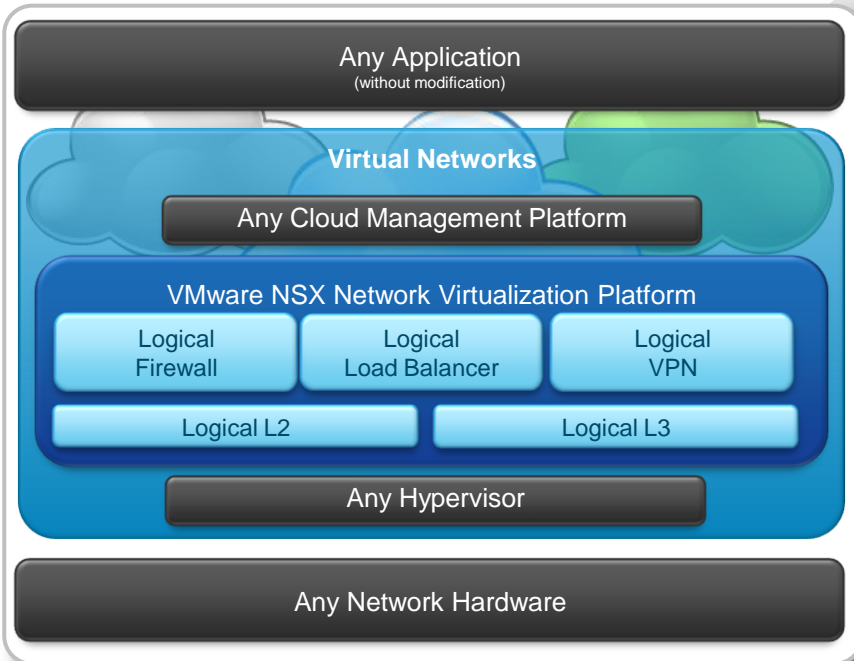

Automation & Operations

- API Driven Integration
- Service Composer for Security Workflows
- Server Access Monitoring
- Troubleshooting & Visibility

Rich Networking & Security Services

- Scalable Logical Switching
- Physical to Virtual L2 Bridging
- Dynamic L3 Routing: OSPF, BGP, IS-IS
- Logical Services:
Firewall, Identity-based Firewall, Load-balancing, VPN (IPSec, SSL, L2VPN)

Partner Extensibility

- Physical ToR L2 Integration
- Security Services – IDS / IPS, AV, Vulnerability Mgmt
- Network Services – Load Balancers, WAN Optimization

Thank You!

thartman@vmware.com

Twitter: @hartmant

Confidential

vmware®